

---

**EN**

## **WOOD STOVE**

*INSTALLATION, USE AND MAINTENANCE MANUAL*

---



**VIOLETTA - MINIWOOD**



## Summary





<b>1</b>	<b>MANUAL SIMBOLOGY</b> .....	<b>3</b>
<b>2</b>	<b>DEAR CUSTOMER</b> .....	<b>3</b>
<b>3</b>	<b>CAUTIONS</b> .....	<b>4</b>
<b>4</b>	<b>SPARE PARTS</b> .....	<b>4</b>
<b>5</b>	<b>DISPOSAL</b> .....	<b>4</b>
<b>6</b>	<b>PACKAGING AND HANDLING</b> .....	<b>4</b>
6.1	PACKAGING.....	4
6.2	STOVE HANDLING.....	4
<b>7</b>	<b>CHIMNEY FLUE</b> .....	<b>5</b>
7.1	INTRODUCTION.....	5
7.2	CHIMNEY FLUE .....	5
7.3	TECHNICAL FEATURES .....	5
7.4	HEIGHT-DEPRESSION.....	6
7.5	MAINTENANCE .....	6
7.6	CHIMNEY POT .....	6
7.7	CHIMNEY COMPONENTS.....	7
7.8	EXTERNAL AIR INLET .....	7
7.9	CHIMNEY FLUE CONNECTION.....	8
7.10	EXAMPLES OF CORRECT INSTALLATION ...	9
<b>8</b>	<b>FUEL</b> .....	<b>10</b>
8.1	FUEL.....	10
<b>9</b>	<b>INSTALLATION</b> .....	<b>12</b>
9.1	INTRODUCTION.....	12
9.2	OVERALL DIMENSIONS.....	13
9.3	GENERAL INSTALLATION .....	14
9.4	ELECTRIC CONNECTION.....	14
<b>10</b>	<b>USE</b> .....	<b>15</b>
10.1	ATTENTION.....	15
10.2	INTRODUCTION.....	15
10.3	IGNITION.....	15
10.4	STOVE REFILLING.....	15
10.5	ADVERSE WEATHER CONDITIONS .....	16
10.6	CREOSOTE DANGER .....	16
10.7	FIRE EXTINGUISHING IN CASE OF FIRE.....	16
<b>11</b>	<b>MAINTENANCE</b> .....	<b>16</b>
11.1	INTRODUCTION.....	16
11.2	BURNING POT AND ASH TRAY CLEANING .....	17
11.3	FUME PIPES ANNUAL CLEANING .....	17
11.4	GENERAL CLEANING .....	17
11.5	CLEANING OF PAINTED METAL PANELS	17
11.6	GASKET REPLACEMENT .....	17
11.7	GLASS CLEANING .....	17
11.8	HEART BREAK .....	18
<b>12</b>	<b>IN CASE OF ANOMALY</b> .....	<b>18</b>
12.1	PROBLEM SOLVING .....	18

## 13 TECHNICAL DATAS .....20

### 13.1 FEATURES .....20

# 1 MANUAL SIMBOLOGY

- The icons with the stylized figures indicates whom the subject dealt in the paragraph is addressed to (between the User and/or the Authorized Technician and/or the Specialized Stove-repairer).
- WARNING symbols indicates an important note.

	<p><b>USER</b></p>
	<p><b>AUTHORISED TECHNICIAN</b>  <b>(ONLY to interpret or the Stove-manufacturer or the Authorized Technician of Technical Assistance Service approved by the Stove-manufacturer)</b></p>
	<p><b>SPECIALIZED STOVE-REPAIRER</b></p>
	<p><b>CAUTION:</b>  <b>READ CAREFULLY THE NOTE</b></p>
	<p><b>CAUTION:</b>  <b>DANGER OR IRREVERSIBLE DAMAGE POSSIBILITY</b></p>

# 2 DEAR CUSTOMER

- Our products are designed and manufactured in compliance with standards EN 13240 for wood stoves, EN 14785 for pellet stoves, EN 13229 for fire places, EN 12815 for wood cooker stoves, Dir.89/106/CEE for manufacturing products, Re n.1935/2004 for materials and objects which are in contact with foods, Dir. 2006/95/CEE for low tension, Dir.2004/108/EC for Electromagnetic compatibility.
- Read carefully the instruction contained in this manual to obtain the best efficiency.
- This instruction manual is an integral part of the product: make sure it is delivered with the appliance also in case of sold to others. In case of loss please ask a copy to your local Technical Assistance Service.
- All local regulations, including those referring to national European standards, must be respected during appliance installation.



In Italy biomass system installation below 35 kW must comply with MD 37/08. Every qualified installer who own these requirements, has to issue the certificate of conformity for the installed system ("system" means: stove + chimney + air inlet).

- According to (EU) No. 305/2011 regulation, the " Declaration of Performance" is available online at the web sites [www.cadelsrl.com](http://www.cadelsrl.com) / [www.free-point.it](http://www.free-point.it).

### 3 CAUTIONS

- All the pictures carried in this manual are only for indicative and explanatory purpose and could therefore slightly differ from your appliance.
- The referring appliance is those you purchased.
- In case of doubts or difficulties in the comprehension or for problems not described in this manual, please promptly contact your distributor or installer.
- It is forbidden to modify the appliance without authorization.

### 4 SPARE PARTS

For each repair or adjustment which should be necessary, please contact the dealer where you purchased your stove or your nearest Technical Assistance Service, specifying:

- Appliance model
- Serial number
- Type of problem

Use only original spare parts which you can find at our Technical Assistance Services.

### 5 DISPOSAL

(European directive 2002/96/CE)



Fig. 1 - Disposal

This symbol on the product means that used electric and electronic products must not be mixed with domestic waste.

For a proper disposal, recovery and/or recycling, please take this product to an authorized waste collection points, where they will be accepted for free. For further instructions, please contact your local authority or your nearest waste collection point. In case of wrong disposal of this waste material there could be applied penalties as provided by national laws.

### 6 PACKAGING AND HANDLING



#### 6.1 PACKAGING

- The packaging is made up of recyclable cardboard boxes according to RESY standards, recyclable expanded polystyrene inserts and wooden pallets.
- All packaging materials can be re-used for a similar use or eventually discharged as waste assimilable to the municipal solid ones, in accordance with current regulations.
- After having removed the packaging please assure you about the integrity of the product.



Packaging are not toys and could cause suffocation or strangulation and other health hazards! People (children included) with reduced mobility, psychological diseases or without experience and knowledge must be kept away from packaging. The stove is not a toy, please see **ATTENTION page 15**.

#### 6.2 STOVE HANDLING

Both whether the stove is packed or not it is necessary to observe the following instructions for handling and transporting the stove from its sale point to its installation point and for any future movements:

- The stove must be handled with idoneous means paying attention to the existing safety regulations;
- do not turn the stove upside down and/or upset it on one side, but keep it in vertical position or as accorded with the constructor instructions;
- if the stove is made up of ceramic, stone, glass or any particularly fragile material components, all must be moved with the utmost care.

## 7 CHIMNEY FLUE



### 7.1 INTRODUCTION

This chapter about the Chimney Flue has been drawn up in cooperation with Assocosma ([www.assocosma.org](http://www.assocosma.org)) and is based on European Standards (EN 15287 - EN 13384 - EN 1856 - EN 1443 - UNI 10683:2012).

It provides instructions for a good and correct execution of the chimney flue but it does not absolutely replace the current standards which the qualified manufacturer/installer should comply with.



Please check with your local authorities if exists any restrictive regulation which regards the combustible air inlet, the fumes exhaust system, the chimney flue and the chimney pot.

The company declines any responsibility regarding the bad running of the stove if it is due to the use of a no correctly dimensioned chimney flue which does not respect current regulations.

### 7.2 CHIMNEY FLUE

- The chimney flue or chimney is of great importance for the correct running of the heating appliance.
- It is fundamental that the chimney flue is perfectly built and always maintained with a perfect efficiency.
- The chimney flue must be sole with insulated stainless-steel pipes or installed on the existing chimney flue.
- Both this solutions must be endowed with an inspection door.

### 7.3 TECHNICAL FEATURES

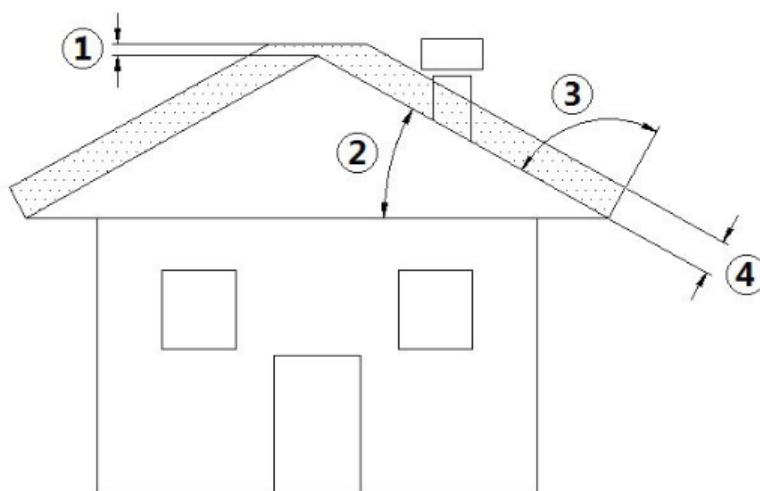

Fig. 2 - Inclined roof

#### LEGEND Fig. 2 page 5

1	Height over the ridge of the roof = 0,5 mt
2	Roof inclination $\geq 10^\circ$
3	$90^\circ$
4	Measured distance at $90^\circ$ from the roof surface = 1,3 mt

- The chimney flue must be sealed from fumes.
- It must have a vertical run without narrowing. It must be realized with fume and condensation resistant materials with thermal insulation and able to last against usual mechanical stresses.



It must be insulated to avoid condensation and to reduce fume cooling effects.

- The stove must be spaced out from fuels or flammable materials with an air gap or with insulating materials. Check the distance with the chimney manufacturer.
- The chimney entrance must be placed in the same room where the appliance is installed or otherwise in

the adjacent room and it must be provided with a solid and condensation collection chamber under the entrance, accessible through the sealed metal gate.

- The inner section of the chimney flue can be round (the best one) or square and the jointed sides must have a minimum radius of 20 mm.
- The section dimension must be minimum  $\varnothing 150$  mm and maximum  $\varnothing 240$  mm.
- Made the efficiency of the chimney flue overhauled by an expert stove-repairer and if necessary cover the chimney flue with materials in compliance with current regulations.
- The flue system must be placed on the roof.
- The chimney flue must be provided CE in accordance with EN 1443 regulation. Please find attached an example of label:



Fig. 3 - Example of label

## 7.4 HEIGHT-DEPRESSION

The depression (draught) of a chimney flue depends also on its height. Check the depression with the values provided at **FEATURES page 20**. Minimum height 3,5 meters.

## 7.5 MAINTENANCE

- The chimney flue must be cleaned, since the soot and unburnt oil deposits reduce its section so blocking the draught. In great quantities they can flare up.
- The fumes extraction pipes (fumes conduit + chimney flue + chimney pot) must always be cleaned, scrubbed and checked by an expert stove-repairer, in compliance with current regulations, with the instructions of the stove-manufacturer and the directives of your insurance company.
- In case of doubts, please follow the most restrictive regulations.
- Have your chimney flue and chimney pot checked and cleaned by an expert chimney sweep at least once a week. The chimney sweep has to release a written declaration about the security of the system.
- Not cleaning compromise safety.

## 7.6 CHIMNEY POT

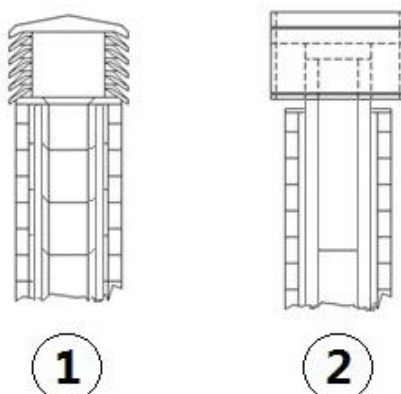

Fig. 4 - Anti-wind chimney pots

The chimney pot is important for the correct running of the heating appliance:

- We recommend using an anti-wind chimney pot, see **Fig. 4 page 6**.
- The hole width for fumes exhaust must be the double of the chimney flue width and fitted in a way that the fume exhaust is assured also in case of wind.
- It should prevent the infiltration of rain, snow and animals.
- The outlet height in the atmosphere must be away from the reflux area caused by the roof structure or by obstacles laying nearby (see **TECHNICAL FEATURES page 5**).

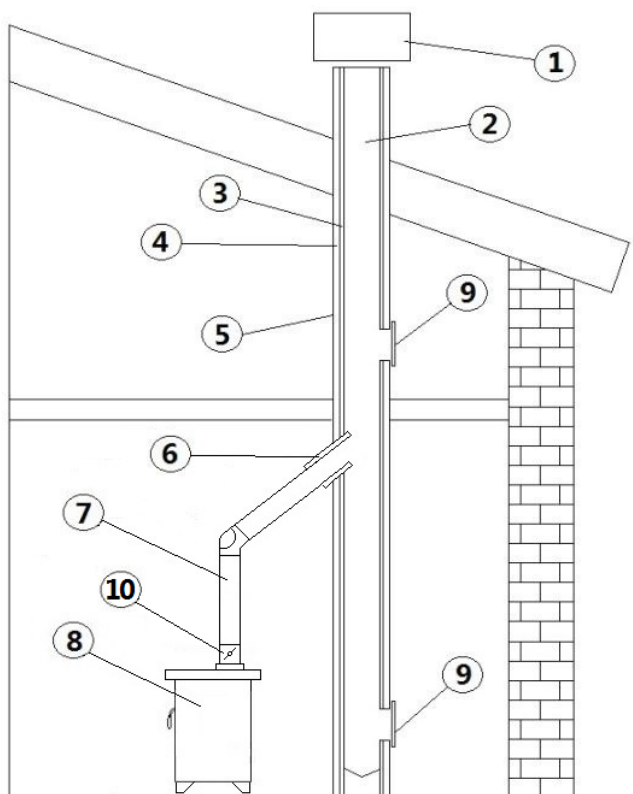

Fig. 5 - Chimney components

LEGEND	Fig. 5 page 7
1	Chimney pot
2	Fume outlet
3	Chimney flue
4	Thermal insulation
5	External wall
6	Chimney union
7	Fume pipe
8	Heat generator
9	Inspection door
10	Damper

7.8 **EXTERNAL AIR INLET**

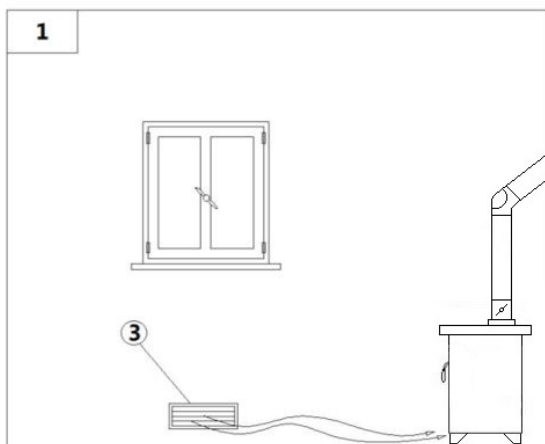

Fig. 6 - Direct air inflow

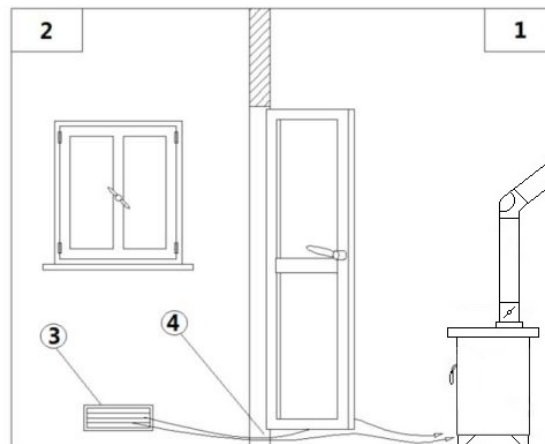

Fig. 7 - Indirect air inflow

LEGEND	Fig. 6 page 7-Fig. 7 page 7
1	Room to ventilate
2	Adjacent room
3	External air inlet
4	Cleft under the door

- The room must be endowed with an external air recycling for a good climate in your ambient.
- The air inflow from outside to the inner occurs directly, through an opening on the external wall of the room (see **Fig. 6 page 7**); otherwise it occurs indirectly by air suction from rooms adjacent to the one to ventilate (see **Fig. 7 page 7**).
- Bedrooms, garages, and store of flammable materials are excluded.
- The air inlet should have a total net surface of 100 sqcm<sup>2</sup>: the aforesaid surface is to widen if inside the room there are other activated appliances (for example: electric ventilators for foul air suction, cooker hoods, other stoves, etc...) which depress the environment.
- At switched on appliance it is necessary to check that the pressure fall between the room and the outside does not exceed 4,0 Pa value: if necessary widen the air inlet (EN 13384).
- The air inlet must be realized at a height close to the floor with an external grid against birds. In such a way it cannot be obstructed by any object.
- In case of installation with sealed-chamber the air inlet is not necessary.

## 7.9 CHIMNEY FLUE CONNECTION

Your stove works through a natural draught. It is obligatory to check that all pipes are realized in compliance with the following regulation on material selection: EN 1856-1, EN 1856-2 e UNI/TS 11278. All must be effected by specialized personnel or companies as provided by UNI 10683:2012.

- The connection between the appliance and the chimney flue should be short in order to favor the draught and to avoid condensation in the pipes.
- The fume conduit should be equivalent or longer than the outlet joint ones.
- Some stove models are endowed with a lateral and/or back exhaust. Check that the unused exhaust is sealed with the plug given with standard equipment.

SYSTEM TYPE	Ø150 mm PIPE	Ø240 mm PIPE
Minimum vertical length	1,5 mt	2 mt
Maximum length (with 1 union)	6,5 mt	10 mt
Maximum length (with 3 unions)	4,5 mt	8 mt
Maximum number of unions	3	3
Level section (minimum inclination 3%)	2 mt	2 mt
Installation at a height above 1200 m a.s.l.	NO	Obligatory

- Use a specific plate pipe for stoves.
- It is forbidden to use metal, fibre cement or aluminium flexible pipes.
- For change of direction it is obligatory always to use a T-union (or a curve not with right angle) with inspection plug which enables an easy periodic cleaning of the pipes.
- Please assure you that after the cleaning the inspection plugs are sealed with its efficient gasket.
- It is forbidden to connect more appliances to the same fume conduit.
- It is forbidden to convey in the same fume conduit exhausts from overhanging cooker hoods.
- It is forbidden to exhaust flue gases directly from the wall towards the outside and closed spaces also at open top.
- It is forbidden to connect any other appliance (wood stoves, cooker hoods, boilers, etc...).
- The fume conduit must be placed at a distance of minimum 500 mm from flammable or heat-susceptible components.
- The fume conduit must be connected with stove exhaust in a fixed and tight manner, and if required with the insertion of a damper.



## 7.10 EXAMPLES OF CORRECT INSTALLATION

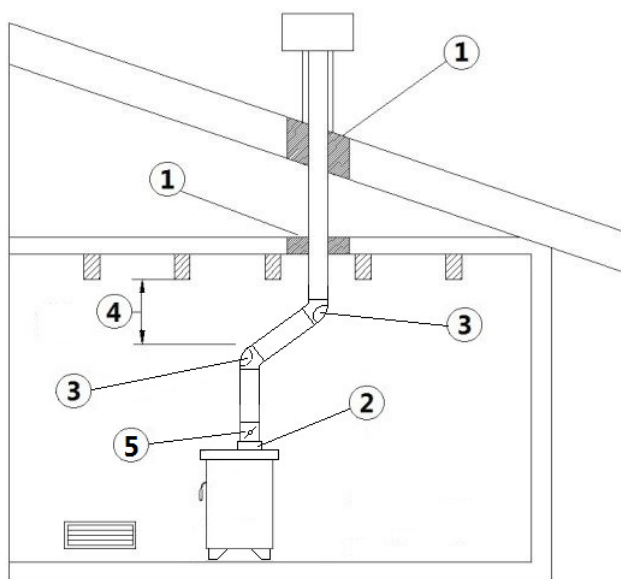

Fig. 8 - Example 1

LEGEND	Fig. 8 page 9
1	Insulating material
2	Reduction from Ø150 to Ø120 mm
3	Inspection plug
4	Minimum safety distance = 0,5 mt
5	Damper

- Chimney flue installation Ø150 mm with an enlarged drilling for pipe transit.

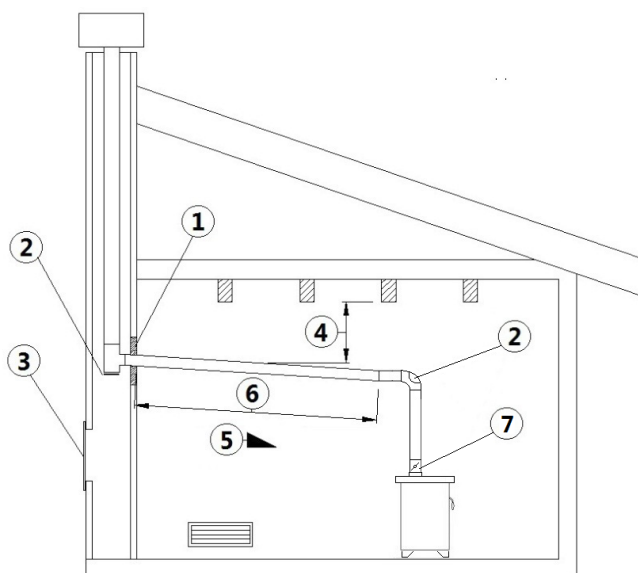

Fig. 9 - Example 2

LEGEND	Fig. 9 page 9
1	Insulating material
2	Inspection plug
3	Chimney inspection entrance
4	Minimum safety distance = 0,5 mt
5	Inclination $\geq 3^\circ$
6	Level section $\leq 1$ mt
7	Damper

- Old chimney flue with an inserted pipe of minimum  $\varnothing 150$  mm and with an external door which enables the chimney cleaning.

EN

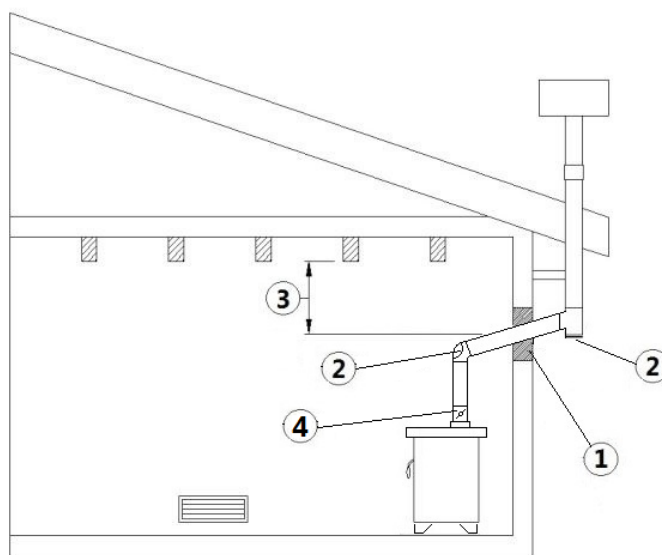

Fig. 10 - Example 3

LEGEND	Fig. 10 page 10
1	Insulating material
2	Inspection plug
3	Minimum safety distance = 0,5 mt
4	Damper

- External chimney flue entirely made up of insulated stainless steel pipes, i.e. with double wall of minimum  $\varnothing 150$  mm: all must be firmly attached to the wall. For chimney against wind effects please (see Fig. 4 page 6).
- Ducting system through T-unions which enables an easy cleaning without disassembling the pipes.



We recommend to check with your chimney flue manufacturer the safety distances which must be respected and the type of insulating material. The aforesaid regulations are valid also for holes made on the wall (EN 13501 - EN 13063 - EN 1856 - EN 1806 - EN 15827).

## 8 FUEL



### 8.1 FUEL

- The allowed fuel is firewood and its derivatives (lignite blocks, compressed sawdust, etc.) with a maximum water content of 20%.
- To obtain good firewood, it must be seasoned outside for at least 2 years in a place protected from the weather.
- Using humid wood or waste bark could create condensation and creosote into the ductions and in the hearth. A heat yield of humid wood is great lower than dry wood.



**Fig. 11 - Wood positioning**

To know the length of wood log to use, check the dimensions of stove combustion chamber. It is advisable to place the wood in horizontal position (see **Fig. 11 page 11**) and adjust the air flow with the aid of the register.

To ignite proper ignitier products can be used.



It is forbidden to use any type of liquid combustible!



It is forbidden to burn wood processing waste containing glue or paint, waste in general and cardboard!

- Here following some information about the quality of different type of woods:

TYPE OF WOOD	QUALITY	% PERFORMANCE
Oak	Excellent	100
Hornbeam	Excellent	100
Ash	Very good	92
Maple	Very good	91
Birch	Good	89
Elm	Good	84
Beech	Good	80
Willow	Sufficient	71
Spruce	Sufficient	70
Red deal	Fair	67
Larch	Fair	66
Lime	Worst	57
Poplar	Worst	50



## 9.1 INTRODUCTION

- The assembly position depends on environment, exhaust, chimney flue.
- Check with local authorities if there are any restrictive regulations which regard the combustible air inlet, room ventilation, fume exhaust system together with chimney flue and chimney pot.
- The manufacturer declines any responsibility in case of installation which are not in compliance with current regulations, in case of a wrong room ventilation system, in case of an electric connection which is not in compliance with regulations and in case of a wrong use of the appliance.
- The installation must be executed by an authorized technician, who must release to the user a declaration of conformity of the system and will assume the whole responsibility on the final installation and on the resulting good running of the product.
- As equipment with the stove there is a testing and maintenance manual which must be periodically executed by the installer.
- Check if there is the combustible air inlet.
- Check the probable presence of other stoves or appliances which could depress the room (see **EXTERNAL AIR INLET page 7**).
- Check at switched on stove if there is the presence of CO in the room.
- Check if the chimney has the necessary draught.
- Check if during the fume passage all has been executed in safety (probable fume losses and distances from flammable materials, etc....).
- The installation of the appliance must enable an easy access for appliance, fume exhaust pipes and chimney flue cleaning.
- The installation must enable an easy access to the electric connection plug (see **ELECTRIC CONNECTION page 14**).
- It is forbidden to install the stove in bedrooms, bathrooms and in rooms used for storing combustible materials and in one-room flats.
- In any case the stove must not be installed in rooms where it can get in touch with water or water splashes because this can cause burn hazards and short-circuit.
- To install more appliances, the external air inlet must be correctly dimensioned (see **EXTERNAL AIR INLET page 7**).
- Only in room used as kitchen is possible to use appliances for cooking with its hood without steam extractor.
- Only type "C" appliances are allowed and not type "B": make reference to regulations active in the country where the appliance is installed.

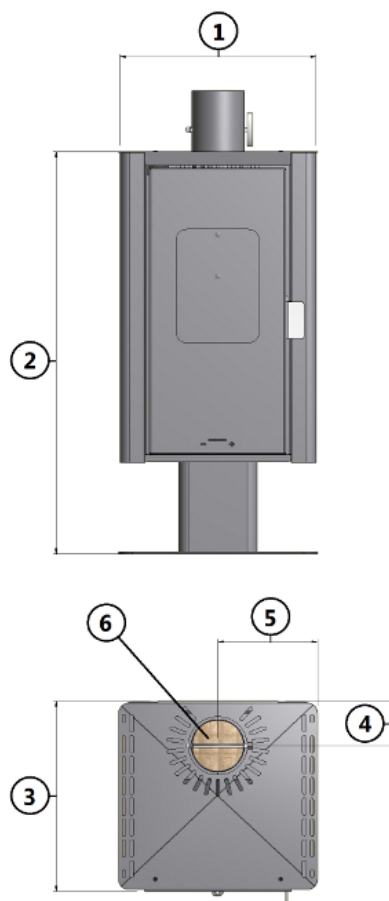

Fig. 12 - Overall dimensions

LEGEND	Fig. 12 page 13
1	38 cm
2	77,4 cm
3	36,5 cm
4	8,5 cm
5	19 cm
6	Exhaust fumes d.10 cm

### 9.3 GENERAL INSTALLATION

EN

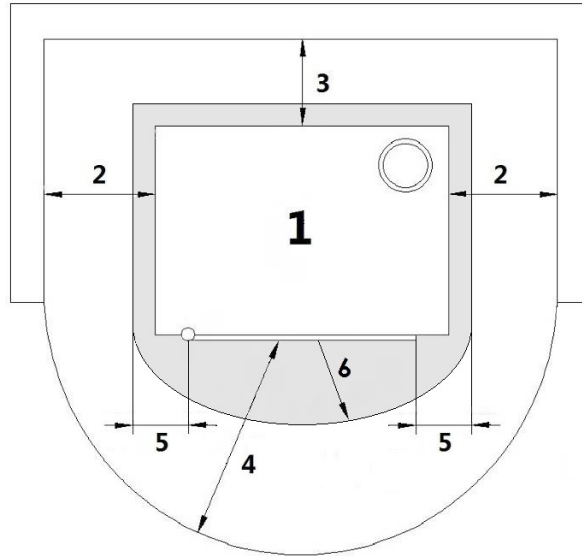

Fig. 13 - General installation

LEGEND	Fig. 13 page 14
1	Stove
2	Minimum lateral distance = 350 mm
3	Minimum rear distance = 400 mm
4	Minimum front distance = 900 mm
5	300 mm
6	500 mm

- Please check that the floor has an adequate load capacity. If the existing one does not satisfy this requirement, appropriate measure should be provided (for example a plate for distributing the load).
- It is obligatory to install the stove away from walls and/or pieces of furniture, with a minimum air flow of 350 mm on the sides and 400 mm on the back, to enable an efficient appliance cooling and a good distribution of heat in the room (see **Fig. 13 page 14**).
- For safety fire regulations the distances from flammable or sensible to heat objects (sofas, pieces of furniture, wooden covering, etc...) must be respected, as described in **Fig. 13 page 14**.
- If there are highly flammable objects (curtains, fitted carpet, etc...), all these distances must be further increased with 1 meter.
- If the walls are made up of flammable materials, check the safety distances (see **Fig. 13 page 14**).
- At maximum power check that the wall temperature does not ever exceed 80°C. If it would be necessary please install a fire resistant plate on the concerned walls.
- In some countries also masonry load-bearing walls are considered flammable.

### 9.4 ELECTRIC CONNECTION

Some wood stove models are endowed with a forced ventilation system, so they need an electric connection.



Warning: the appliance must be installed by an authorized technician!

- The electric connection occurs through a cable with plug put in an electric socket which is able to support charge and tension specific of every model, as described in the technical datas table (see **FEATURES page 20**).
- The plug must be easily accessible when the appliance is installed.



The cable must not get in touch with the fume exhaust pipe and nor with every other part of the stove.

- Please further assure you that your network is endowed with an efficient earth connection: if it does not exist

or if it is not efficient, please endow you with one in compliance with the law.

- Do not use extension cables.
- If the feeder cable is damaged, it must be replaced by an authorized technician.
- When the stove is not going to be used for a long period of time, it is advisable to remove the plug from the socket on the wall.



## 10 USE

### 10.1 ATTENTION



This appliance must not be used by people (children included) with reduced mobility, psychological diseases or without experience and knowledge except in case of supervision or instruction about the use of the appliance by people responsible for their safety.



Children must be constantly overseen in order to assure that they do not play with the appliance.



During its running, the stove reaches high temperatures: keep away children and animals and for your safety please use appropriate fireproof devices, such as heat-protecting gloves.

### 10.2 INTRODUCTION

To have the best performance with the lowest consumption please follow the here described instructions.

- Wood ignition occurs very easily if the installation is correct and if the chimney flue is efficient.
- By first ignition of the stove hold a slow fire for at least 4-5 hours in order to allow the material of which the heater and the hearth are made up of to adjust the inner mechanical stresses. This operation must be executed at least 3-4 times a year.
- Plant fat waste and varnishes can release bad smells and smoke during first working hours: it is advisable to ventilate the room because they can be noxious to people and animals.



Do not use flammable liquids during the ignition (alcohol, petrol, oil, etc...).

### 10.3 IGNITION

- If inside the combustion chamber there are booklets, manuals, etc..., remove them.
- Check if the plug is correctly inserted in the electric socket (only for stoves with forced ventilation).
- Completely open the primary air inlet register and the damper.
- Put the fire-starter bars and seasoned wood logs into the burning pot.
- Ignite the bars and right after insert well seasoned wood logs and close the oven door.

For a better yield, as soon as there is a live flame, it is advisable to close the primary air valve to the minimum and keep the damper at 45° in order to have the maximum performance (nominal output) with the lowest fuel consumption.

### 10.4 STOVE REFILLING



During stove refilling do not wear flammable or large clothing.



Do not open and close the fire door violently: the glass can brake!



Open the fire door with naked flames can be dangerous for user and/or home.



During operation some external parts can reach high temperatures. During refilling fases use proper protection gloves given as equipment.

- It is advisable to refill the stove only when on the firebox are only embers.
- Please proceed as follows: close the primary air valve, open the fire door slowly, shake the ash with the appropriate instrument, insert wood in the hearth, close the door and adjust again the primary air valve.



During regular working is dangerous to keep open the ash drawer and/or the fire box to increase air draught! There are appropriate instruments to adjust combustion air (primary air valve, register, etc...).

## 10.5 ADVERSE WEATHER CONDITIONS

When the external temperatures are severe and/or there are adverse weather conditions (strong wind), the chimney is subjected to a lack in draught thus impeding a correct fume expulsion.

- Fill the heart with few wood logs and keep air register valves opened completely.

## 10.6 CREOSOTE DANGER

The use of humid and/or bad quality wood (for example resinous wood) cause creation of creosote along the chimney flue obstructing fume passages. The creosote is flammable and if amassed over the time it must be removed in order to prevent the risk of fire of the chimney flue.

- In case of fire close air register valves and contact immediately the firemen.
- When the chimney has stopped burning, have the chimney flue checked by an expert stove-repairer.

## 10.7 FIRE EXTINGUISHING IN CASE OF FIRE

In case it would be necessary to extinguish the fire emitted by the stove or by the chimney flue, use a fire-extinguisher or contact the firemen. DO NOT use water to extinguish the fire inside the burning pot.

# 11 MAINTAINANCE



## 11.1 INTRODUCTION

For a long working life of the stove, have a periodic cleaning of the stove as described in the following paragraphs.

- Fume outlet pipes (fume conduit + chimney flue + chimney pot) must always be cleaned, scrubbed and checked by an authorized technician in compliance with local regulations, with the instructions of the manufacturer and those of your insurance company.
- If there are no local regulations and no instruction from your insurance company, it is necessary to have your fume pipe, chimney flue and chimney pot cleaned at least once a year.
- It is also necessary to have the combustion chamber, motors and fans cleaned and to have the gaskets and the electrical elements (if there are) checked at least once a year.



All these operations must be planned in time with your Authorized Technical Assistance Service.

- After a long ineffective time, before turning on the stove check if there are obstructions in the fume exhaust.



- If the stove had been using continuously and intensely, the whole system (chimney included), must be cleaned and checked more frequently.
- In case of replacement of damaged pieces please ask for the original spare part at the Authorized Retailer.



Before any movement let the fire inside the combustion chamber extinguish till the total cooling and always disconnect the plug from the socket (if there are).

### 11.2 **BURNING POT AND ASH TRAY CLEANING**

For a good combustion, before of every stove ignition, remove the ash which has settled in the burning pot. The abundant ash obstructs the primary air flow which is fundamental for a good combustion.

- Remove ash from the burning pot by shaking it to let it fall in the ash tray.
- If full, the ash tray must be empty.
- Ash must be kept in a metal container with sealed cap, the same container must not ever be in contact with flammable materials (for example lent over a wooden floor), as ash inside keeps embers glowing for a long time.
- Only when the ash is completely extinguished can be thrown in the organic waste.
- Clean the ash also in the ash compartment.



### 11.3 **FUME PIPES ANNUAL CLEANING**

Clean once a year from soot with brushes.  
The cleaning operation must be executed by a specialized stove-repairer who will provide for the cleaning of fume pipe, chimney flue and chimney pot. He will also check their efficiency and will release a written declaration of the safety of the appliance. This operation must be executed at least once a year.



### 11.4 **GENERAL CLEANING**

For cleaning external and inner parts of the stove do not use steel wools, muriatic acid or other corrosive and abrasive materials.



### 11.5 **CLEANING OF PAINTED METAL PANELS**

To clean painted metal panels use a soft cloth. Do not use degreasant agents like alcohol, diluents, acetone, gasoline because these could irremediably damage the varnish.



### 11.6 **GASKET REPLACEMENT**

In case of deterioration of fire door gasket and/or ash door gasket it is necessary to replace them by an authorized technician in order to guarantee the good running of the stove.



Use exclusively original spare parts.



### 11.7 **GLASS CLEANING**

The glass-ceramic of the fire door is able to stand till 700°C but not to thermal shocks.

The probable cleaning with usual sale product for glass cleaning must be effected at cool glass in order to avoid explosions.

### 11.8 HEART BREAK



Probable cast iron or refractory heart break are due to an excessive overheating caused by too much fuel or by too much combustion air. Have the damaged elements immediately replaced in order to avoid feather damages to the stove.



Use exclusively original spare parts.

## 12 IN CASE OF ANOMALY









### 12.1 PROBLEM SOLVING



In case of doubts regarding the use of the stove, please contact ALWAYS the Authorized Technician on order to avoi irreparable damages!

PROBLEM	CAUSE	SOLUTION	INTERVENTION
Ignition difficulties	Too large wood	Use small and well dried wood logs during ignition, before bigger wood logs.	
	Too humid wood	Use well seasoned wood.	
	Lack of chimney draught	Open the registers completely. (If the problem persists, contact an expert stove repairer who will check the chimney flue efficiency).	
	Ambient without air recycling	Create immediately a ventilation grid.	
Creation of condensation	Large chimney flue section	Reduce the chimney flue section with thermal insulater pipes.	
	No insulated chimney flue	Cover the chimney flue with insulating material.	
	Too slow combustion	Open air registers in order to increase the fire and fume output temperature.	

PROBLEM	CAUSE	SOLUTION	INTERVENTION
Fume leakage from the heart	No insulated chimney flue	Cover the chimney flue with insulating material.	
	Adverse weather conditions	No windproof chimney pot: have it replaced.	
	Too humid wood	Use well seasoned wood.	
The glass blackens excessively	Lack of chimney draught	Open the registers completely. (If the problem persists, contact an expert stove repairer who will check the chimney flue efficiency).	
	Too humid wood	Use well seasoned wood	
	Too slow combustion	Open air registers in order to increase the fire and fume output temperature.	
	Bad quality fuel	Use fuel described in <b>FUEL page 10</b>	



### 13.1 FEATURES

DESCRIPTION	VIOLETTA 6,6 kW	MINIWOOD 6,6 kW
WIDTH	38 cm	38 cm
DEPTH	36,5 cm	37 cm
HEIGHT	77,4 cm	77,5 cm
WEIGHT	56 kg	56 kg
NOMINAL THERMIC POWER (Max)	6,6 kW	6,6 kW
EFICIENCY (Max)	82,3 %	82,3 %
FUME TEMPERATURE (Max)	277 °C	277 °C
FUME MAXIMUM LOADING CAPACITY (Max)	4,12 g/s	4,12 g/s
CO EMISSIONS (13% O <sub>2</sub> ) (Max)	0,34 %	0,34 %
CHIMNEY DEPRESSION (Max)	12 Pa	12 Pa
FUME OUTLET DIAMETER	Ø10 cm	Ø10 cm
FUME OUTLET POSITION	Upper	Upper
DAMPER REQUIRED	YES	YES
FUEL	WOOD	WOOD
WOOD HUMIDITY	< 12%	< 12%
HEATING VOLUME 18/20°C Coeff. 0,045 kW (Max)	158 m <sup>3</sup>	158 m <sup>3</sup>
HOURLY CONSUMPTION	1,84 kg/h	1,84 kg/h
BURNING POT VOLUME	19,1 dm <sup>3</sup>	19,1 dm <sup>3</sup>
BURNING POT OPENING	4,9 dm <sup>2</sup>	4,9 dm <sup>2</sup>
ASH TRAY CAPACITY	2,1 dm <sup>3</sup>	2,1 dm <sup>3</sup>
BURNING POT GRID SHAKER	NO	NO
ADJUSTABLE PRIMARY AIR	YES	YES
ADJUSTABLE SECONDARY AIR	NO	NO
FAN	NO	NO
SUPPLY	-	-
POWER INPUT (Max)	-	-
MINIMUM EXTERNAL AIR INLET (last effective area)	100 cm <sup>2</sup>	100 cm <sup>2</sup>







---

**PELLET STOVES · WOOD STOVES · WOOD COOKING STOVES  
THERMOSTOVES · PELLET FIREPLACE INSERTS**

---

**PELLETKACHELS · HOUTKACHELS · HOUTKEUKENS  
THERMOKACHEL · OPEN HAARD PELLETS**

---

**CADEL srl**

FREEPOINT by Cadel

Via Foresto Sud, 7  
31025 Santa Lucia di Piave (TV) - ITALY

tel. +39.0438.738669

fax +39.0438.73343

[www.cadelsrl.com](http://www.cadelsrl.com)

Partner of:

